

Introduction to Neutron Spin Echo Spectroscopy

Laura-Roxana Stingaciu
and
Piotr Adam Zolnierczuk

ORNL is managed by UT-Battelle, LLC for the US Department of Energy



This manuscript has been authored by UT-Battelle LLC under Contract No. DE-AC05-00OR22725 with the US Department of Energy (DOE). The US government retains and the publisher, by accepting the article for publication, acknowledges that the US government retains a nonexclusive, paid-up, irrevocable, worldwide license to publish or reproduce the published form of this manuscript, or allow others to do so, for US government purposes. DOE will provide public access to these results of federally sponsored research in accordance with the DOE Public Access Plan (<http://energy.gov/downloads/doe-public-access-plan>).

This research used resources at the Spallation Neutron Source, a DOE Office of Science User Facility operated by the Oak Ridge National Laboratory.

1. The neutron scattering event

(in the Fraunhofer approximation)

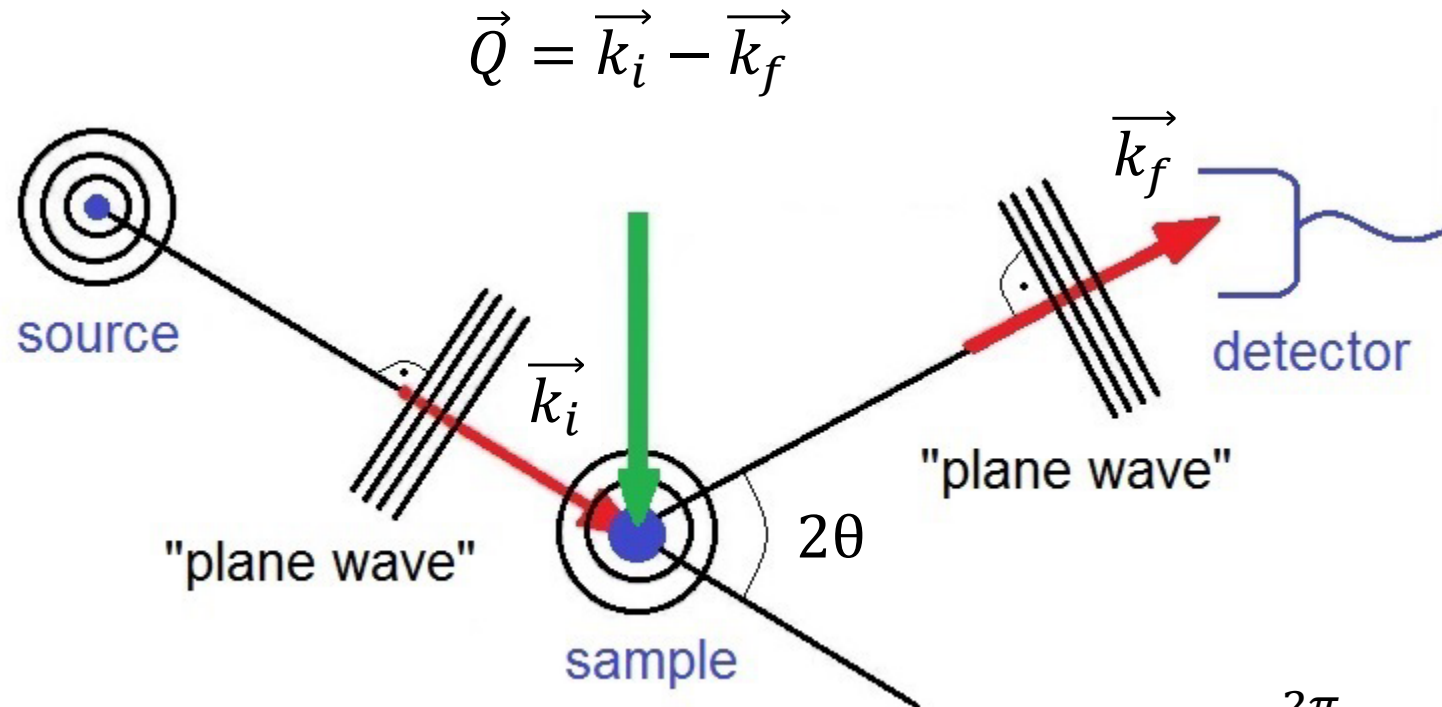

$$\vec{Q} = \vec{k}_i - \vec{k}_f$$

$$\vec{Q} = \vec{k}_i - \vec{k}_f = \text{momentum transfer}$$

$$\Delta E = E_i - E_f = \hbar\omega = \text{energy transfer}$$

$$k = \frac{2\pi}{\lambda} \quad \text{neutron momentum}$$

$$E = \frac{(\hbar k)^2}{2m_n} \quad \text{neutron energy}$$

2. QENS: quasielastic neutron scattering

A limiting case of inelastic scattering, centered at $\omega = 0$ characterized by small energy transfers

Energy spectra = structural and dynamical information

$S(Q, \omega) = \text{dynamic structure factor}$

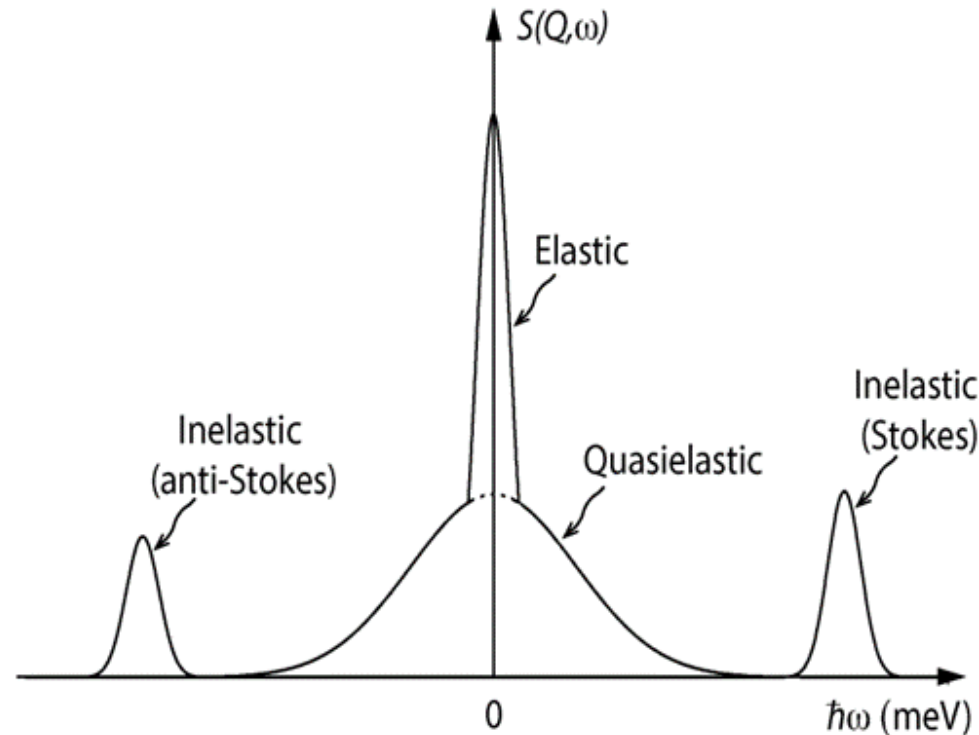

$\omega < 0$ (gain)

$\omega = 0$

$\omega > 0$ (loss)

$$\Delta E = E_i - E_f$$

$$\Delta E \ll E_i$$

- elastic peak
- quasielastic line
- inelastic peaks

3. Neutron spectroscopy landscape

(methods to measure dynamics)

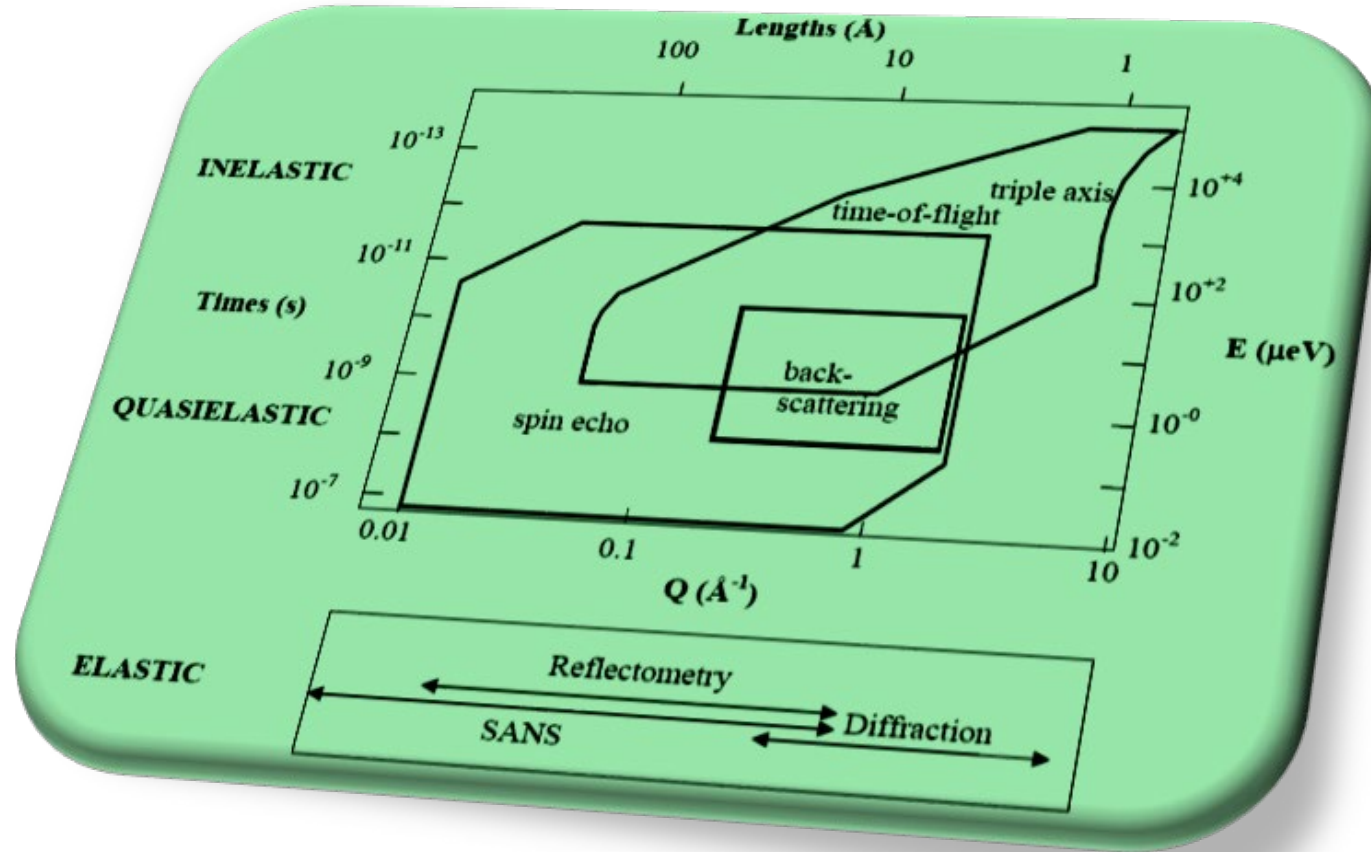

XTL, TOF, XTL-TOF, TOF-TOF, XTL-XTL, TOF-XTL, NSE

$1\text{meV} \sim 8\text{cm}^{-1} \sim 1\text{ps}$

$1\mu\text{eV} \sim 0.008\text{cm}^{-1} \sim 1\text{ns}$

$1\text{neV} \sim 8 \times 10^{-6} \text{cm}^{-1} \sim 1\mu\text{s}$

4. Neutron Spin Echo = NSE - two principles

4.1. Larmor precession

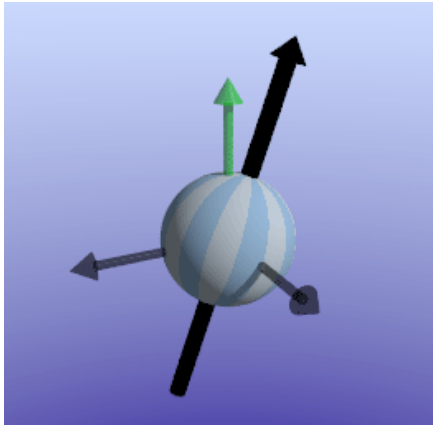

<http://xrayphysics.com/sequences.html>

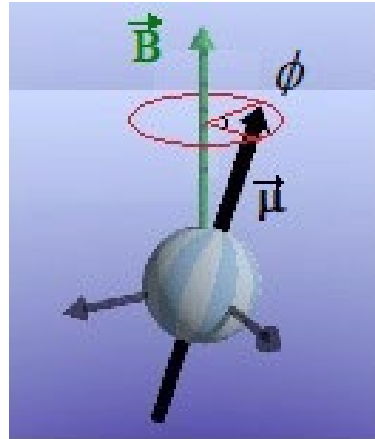

Figure by Laura R. Stingaciu, ORNL

- Larmor Frequency

$$\omega_L = |\gamma B|$$

- Accumulated phase

$$\phi = \omega_L t = \gamma_L B t = \gamma B l \frac{1}{v}$$

- Neutron Gyromagnetic Ratio

$$|\gamma/2\pi| \approx 30 \text{ MHz/T}$$

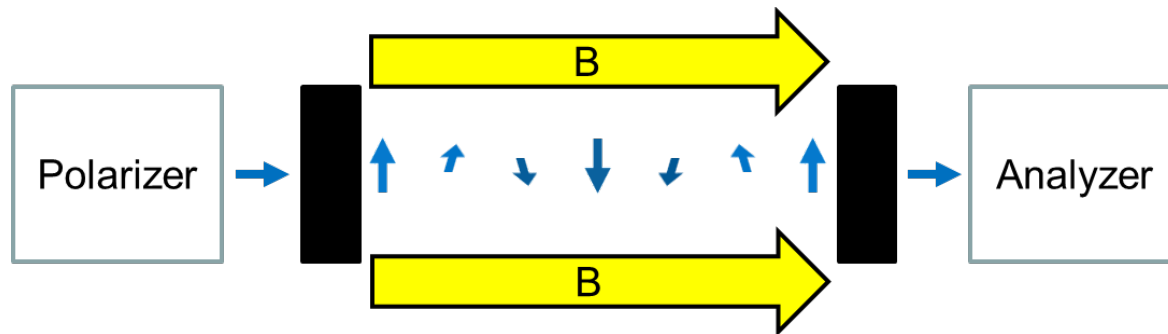

Neutron Spin Echo Spectroscopy by Piotr A. Zolnierczuk, NXS-2017: <https://www.youtube.com/watch?v=tIFysL66PnM>

Neutron Spin Echo = NSE - two principles

4.2. Hann echo

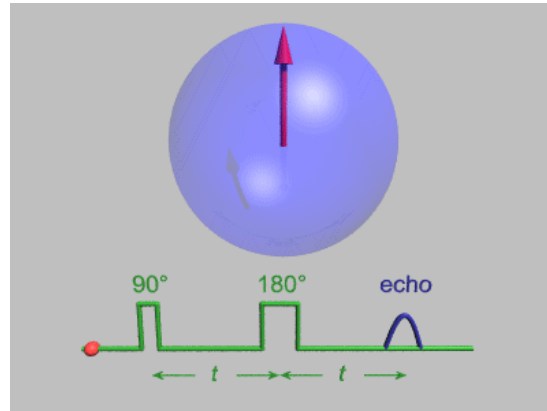

https://en.wikipedia.org/wiki/Neutron_spin_echo

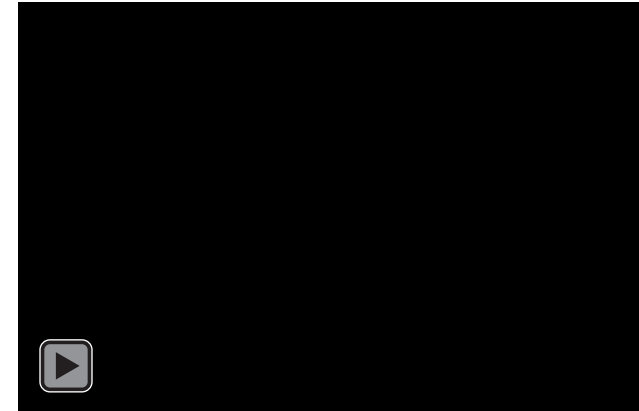

<https://www.oxfordneutronschool.org/2017/Lectures/Fouquet%20-%20Neutron%20Spin%20Echo.pdf>

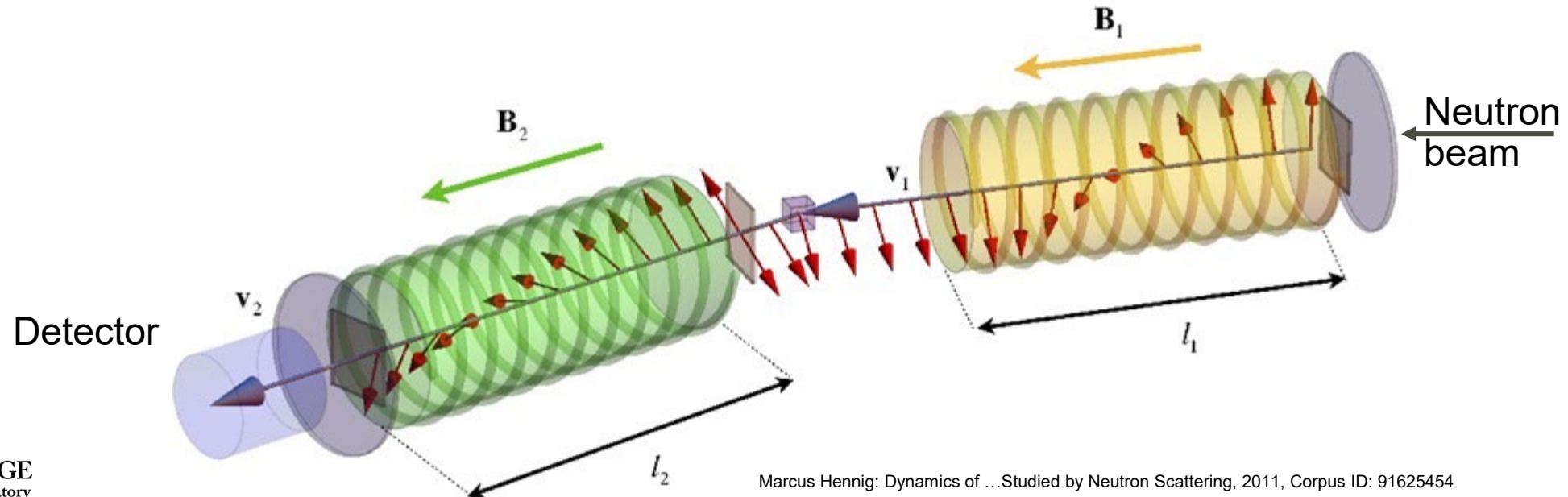

Marcus Hennig: Dynamics of ... Studied by Neutron Scattering, 2011, Corpus ID: 91625454

Neutron Spin Echo – a quasielastic process

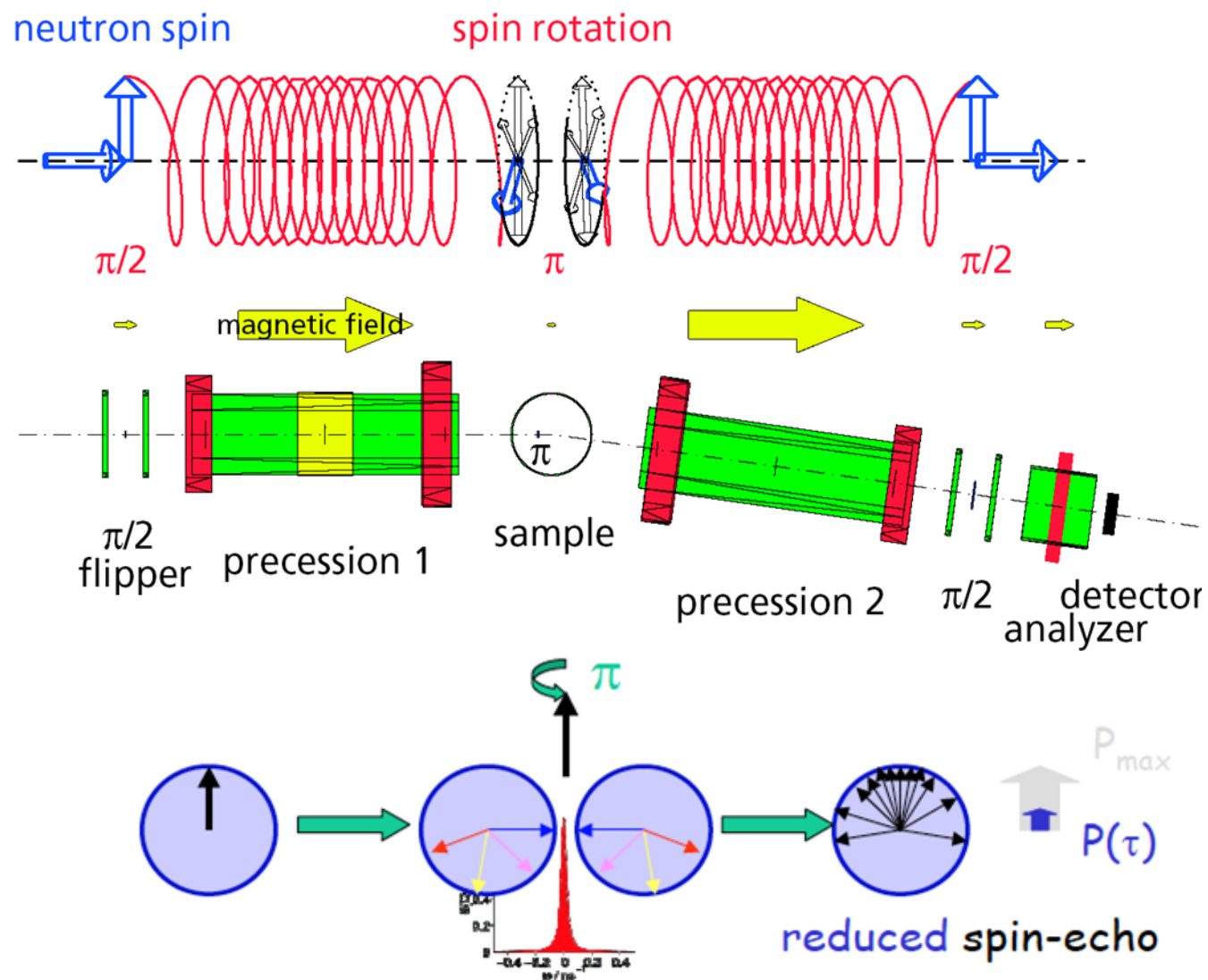

Neutron Spin Echo signal

$$I \sim \langle \cos \phi \rangle = \langle \cos \omega \tau \rangle$$

$$I \sim I(Q) \pm \int S(Q, \omega) \cos(\omega \tau) d\omega$$

↑
Fourier transform
(Real part)
↓

- $B \sim I(Q)$
- $A \sim I(Q, \tau) = \mathcal{F}[S(Q, \omega)]$

- $\frac{I(Q, \tau)}{I(Q, 0)} = \frac{2A}{U-D}$

Fourier time

$$\tau \cong 0.186 J \lambda^3 \text{ [ns]}$$

$$[J] = \text{Tm}, [\lambda] = \text{\AA}$$

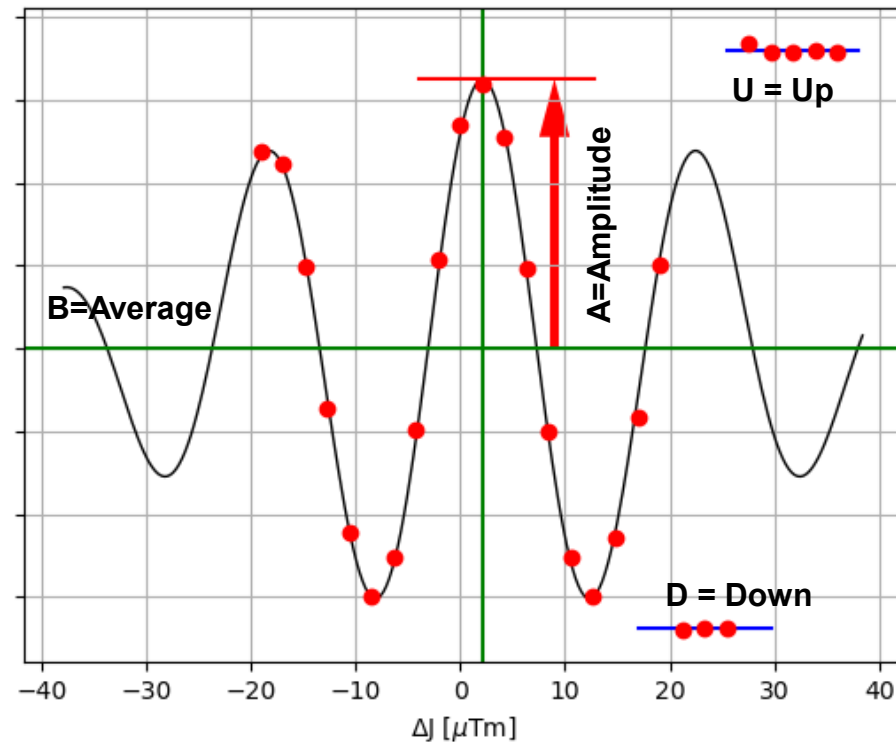

Coherent and incoherent scattering in NSE

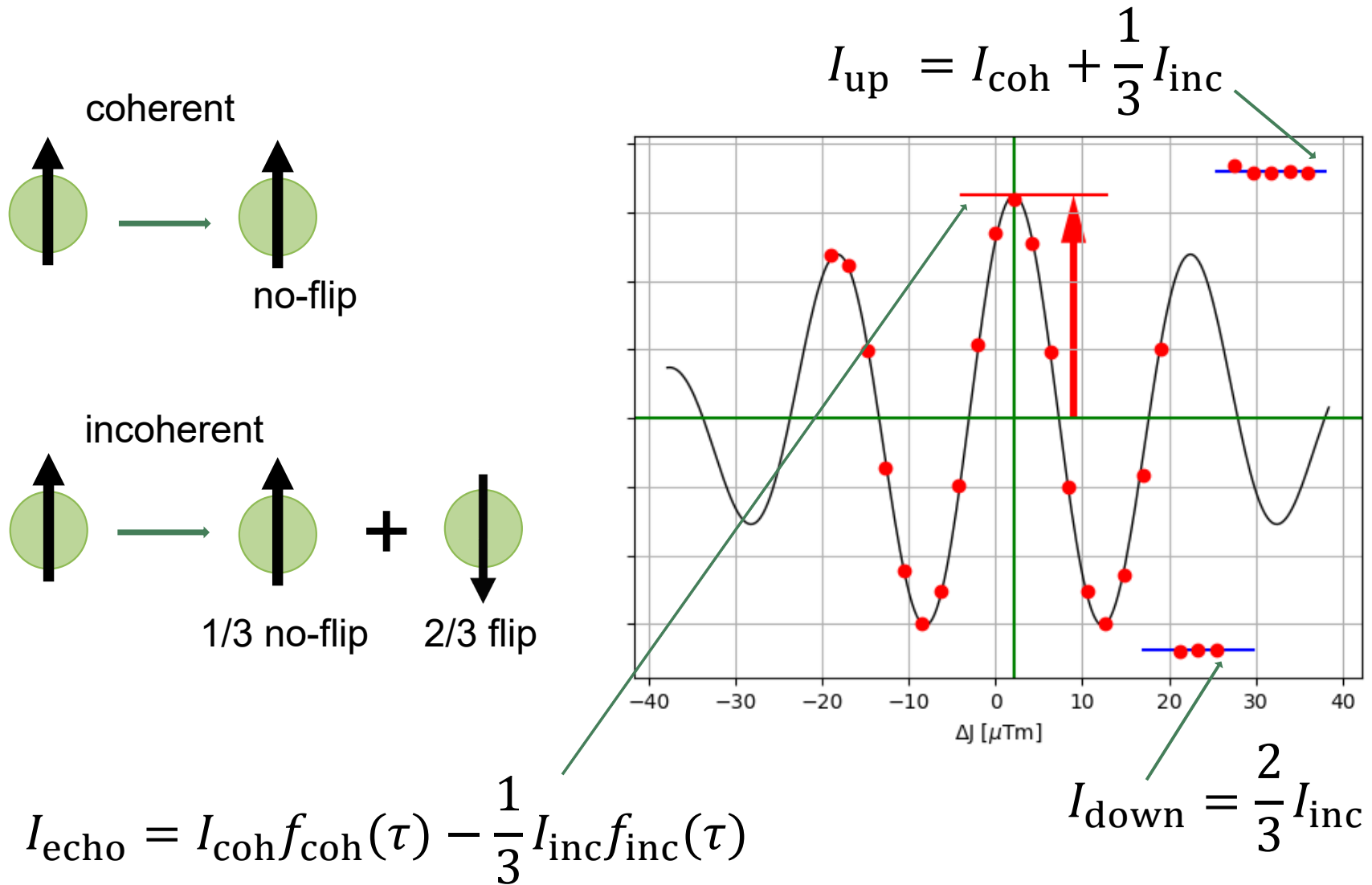

Energy and time domain QENS \leftrightarrow NSE

QENS: Dynamic Structure Factor

NSE: Intermediate Scattering Function

$$S(Q, \omega) \xleftarrow{\text{Fourier Transform}} I(Q, \tau)$$

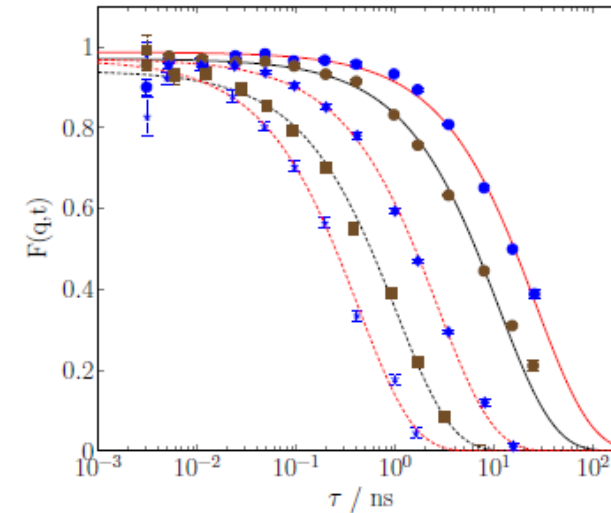
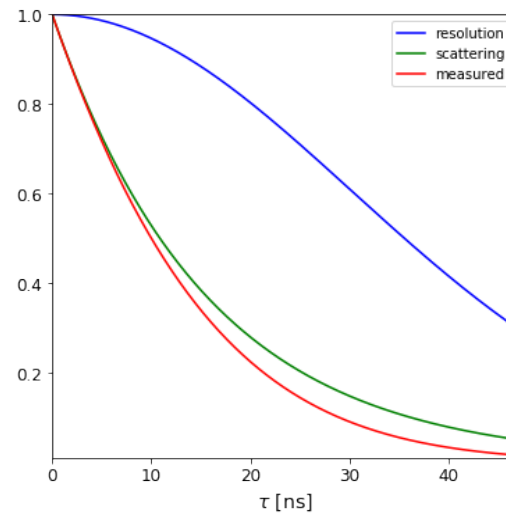
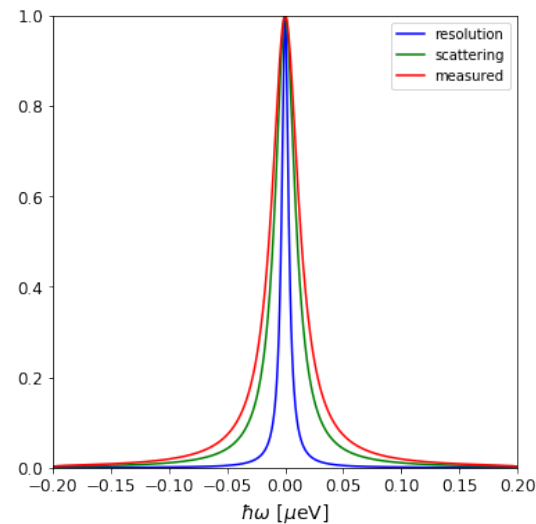

$$I_D(Q, \omega) = S(Q, \omega) * R(Q, \omega)$$

$$I_D(Q, \tau) = I(Q, \tau) R(Q, \tau)$$

NSE spectrometers world map



SNS-NSE overview

- ❑ Ultrahigh resolution spectrometer for characterizing slow dynamics of soft condensed matter @ nanoscopic and mesoscopic scale
- ❑ Detects neutron velocity changes $< 10^{-5}$
- ❑ The only NSE spectrometer at a pulse source
- ❑ The first NSE spectroscopic design based on superconducting technology
- ❑ The only NSE spectrometer with complete magnetic shielding

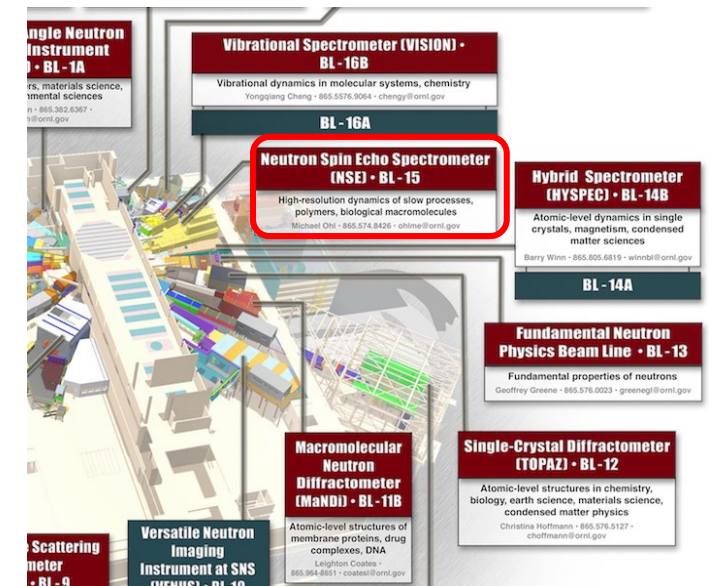

SNS-NSE, the Neutron Spin Echo spectrometer @ SNS

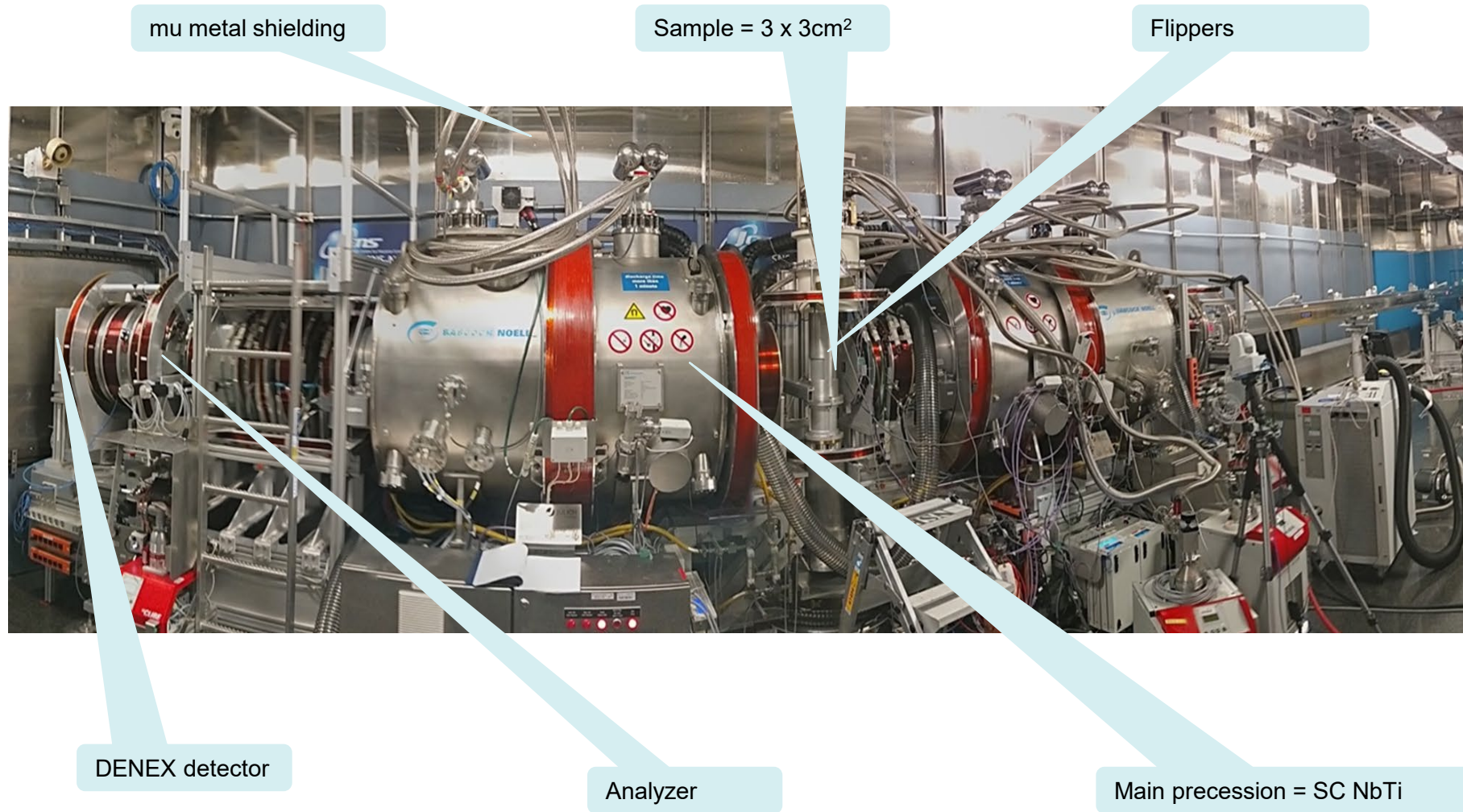

SNS-NSE Sample Environments

ThermoJET Temperature Forcing System (TFS), 275K - 400K

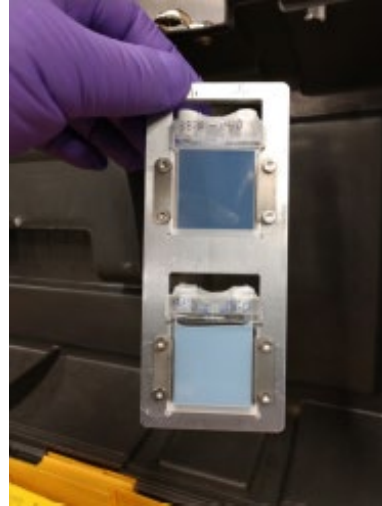

Janis cryostat , 5K - 700K



SNS-NSE Data Reduction For Spin Echo Experiments

DrSPINE

DrSPINE is a unified reactor - pulse source
NSE data reduction software

research papers



Appl Cryst
JAC
JOURNAL OF
APPLIED
CRYSTALLOGRAPHY

ISSN 1600-5767

Received 15 May 2019
Accepted 2 August 2019

Edited by Th. Proffen, Oak Ridge National
Laboratory, USA

Keywords: neutron spin echo; NSE; spallation
neutron sources; data reduction.

Supporting information: this article has
supporting information at journals.iucr.org/j

Efficient data extraction from neutron time-of-flight spin-echo raw data

P. A. Zolnierczuk,^a O. Holderer,^b S. Pasini,^b T. Kozielowski,^c L. R. Stingaciu^d and M.
Monkenbusch^{c*}

^aForschungszentrum Jülich GmbH, JCNS Outstation, Oak Ridge, Tennessee, USA, ^bForschungszentrum Jülich GmbH,
JCNS MLZ, Garching, Germany, ^cForschungszentrum Jülich GmbH, JCNS-1, Jülich, Germany, and ^dNSCD, Oak Ridge
National Laboratory, Oak Ridge, TN 37831, USA. *Correspondence e-mail: m.monkenbusch@fz-juelich.de

Neutron spin-echo spectrometers with a position-sensitive detector and operating with extended time-of-flight-tagged wavelength frames are able to collect a comprehensive set of data covering a large range of wavevector and Fourier time space with only a few instrumental settings in a quasi-continuous way. Extracting all the information contained in the raw data and mapping them to a suitable physical space in the most efficient way is a challenge. This article reports algorithms employed in dedicated software, *DrSpine* (data reduction for spin echo), that achieves this goal and yields reliable representations of the intermediate scattering function $S(Q, t)$ independent of the selected 'binning'.



J-NSE Phoenix courtesy of Olaf Holderer, FRMII

SNS-NSE and TOF

- $\Delta\lambda = (5 - 8) \text{ \AA}$
- $2\theta = 3.6^\circ \quad Q = 0.02 - 0.15 \text{ \AA}^{-1}$
- $2\theta = 37^\circ \quad Q = 0.45 - 0.85 \text{ \AA}^{-1}$

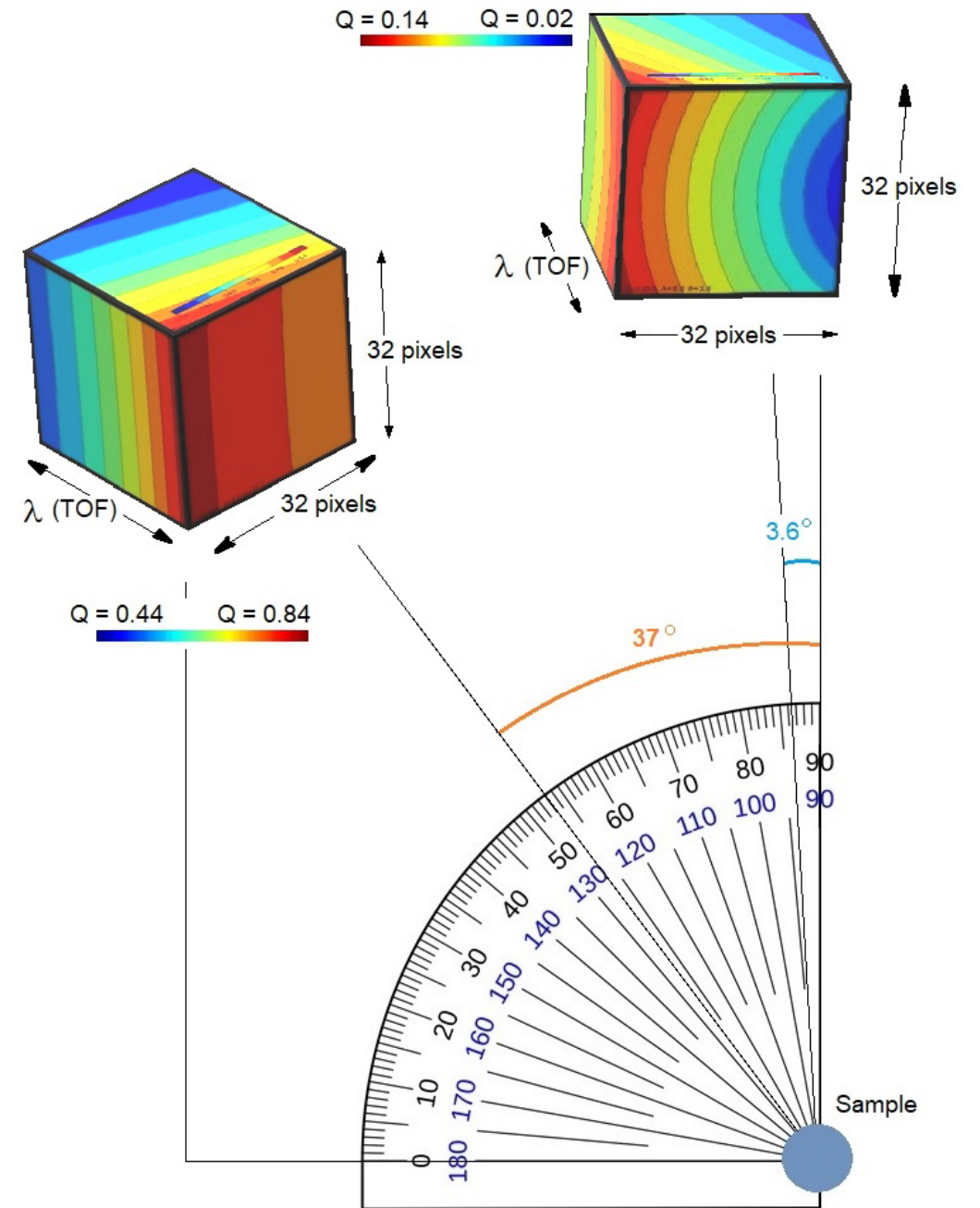
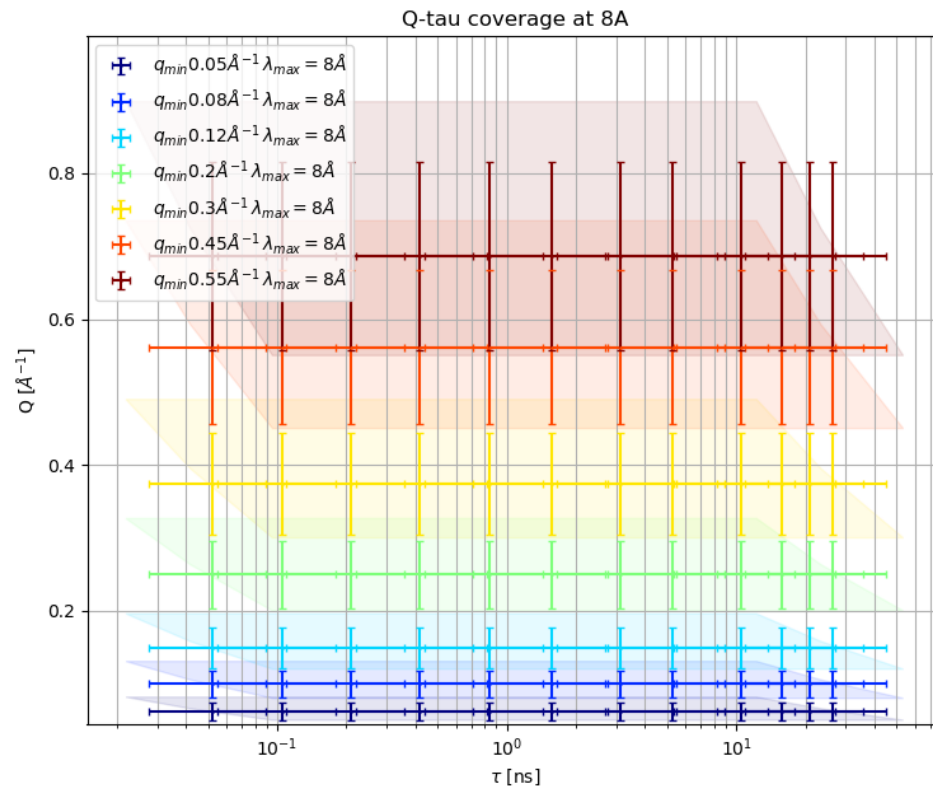

Figure idea and cubes design by Piotr A. Zolnierczuk, 3D rendering by L.R. Stingaciu

*Coherent dynamics in polymers,
glassy systems, bio-macromolecules*

Magnetic Dynamics, Spin glasses & spin fluids

Domain and allosteric motions in proteins

Shape fluctuations

SNS-NSE research highlights

dynamics of soft matter at nano- to meso-scale

Diffusion processes

Hydrogen jump diffusion

Interaction of solvent molecules with surfaces

Short range translational, rotational and tumbling diffusive motions

SDS micelles in aqueous solution

J. Hayter, J. Penfold, *J. Chem. Soc., Faraday Trans. 1*, 1981,77, 1851-1863, <https://doi.org/10.1039/F19817701851>

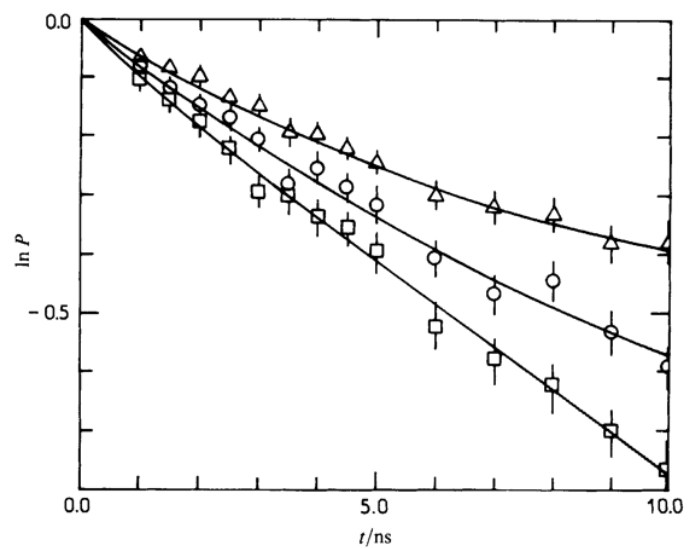
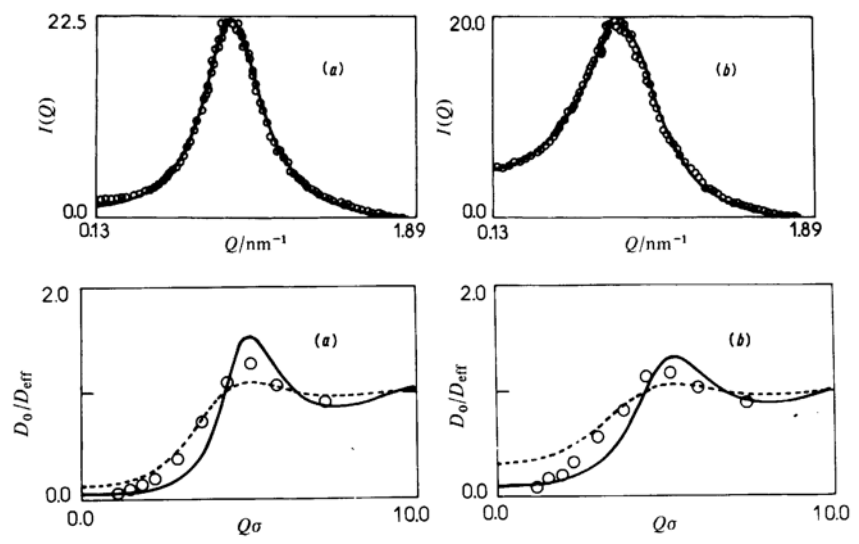
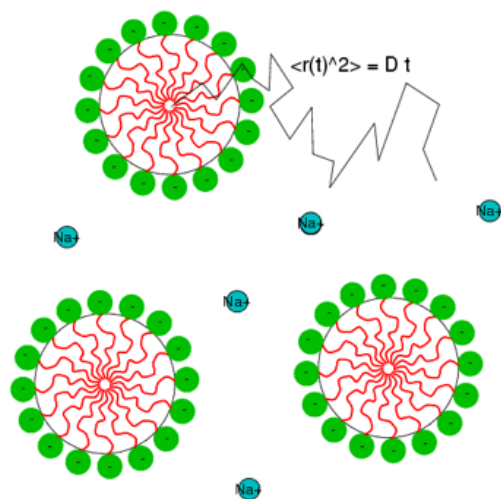

$$\frac{I(Q, t)}{I(Q, 0)} = e^{-D_{\text{eff}}(Q)Q^2 t}$$

$$D_{\text{eff}} = D_0 H(Q) / S(Q)$$

$$D_0 = \frac{kT}{6\pi\eta R} \quad \text{Stokes-Einstein}$$

Motion in entangled polymer melts

A. Wischnewski, M. Monkenbusch, L. Willner,... and D. Richter, *Phys. Rev. Lett.* **90** (2003), DOI: 10.1103/PhysRevLett.90.058302

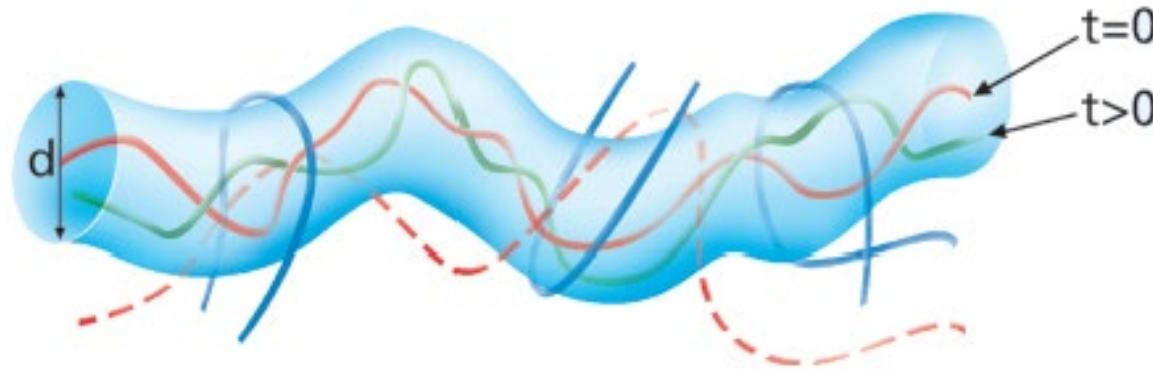

$$\frac{S(Q, \tau)}{S(Q, 0)} = [1 - F(Q)]S^{loc} + F(Q)S^{esc}$$

- ❑ NSE Spin-Incoherent scattering measures proton self-correlation function
- ❑ Labeled long linear PEP polymer chain
- ❑ Segmental dynamics

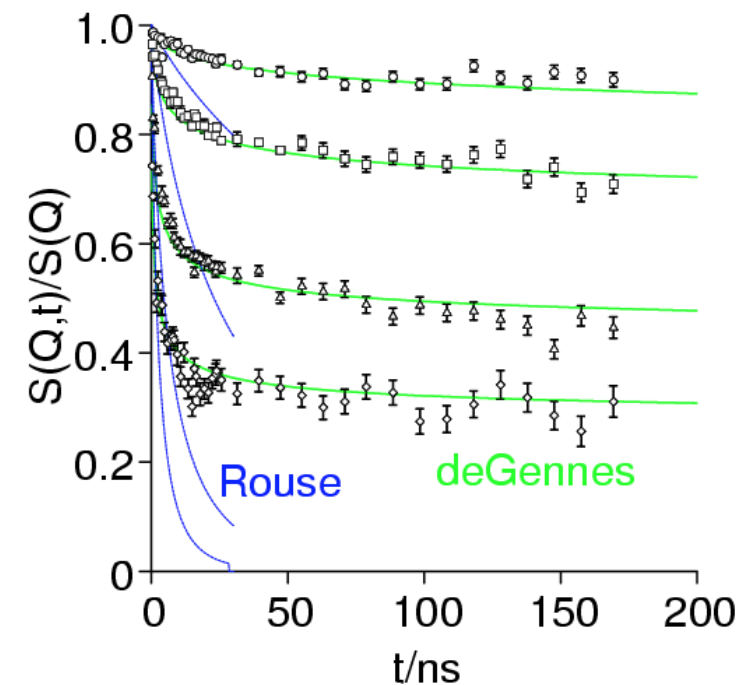

Dynamics of phospholipid membranes

Sudipta Gupta, Piotr Zolnierczuk, Gerald J. Schneider, et al., *J. Phys. Chem. Lett.* 9, 2956 (2018), DOI: 10.1021/acs.jpcllett.8b01008

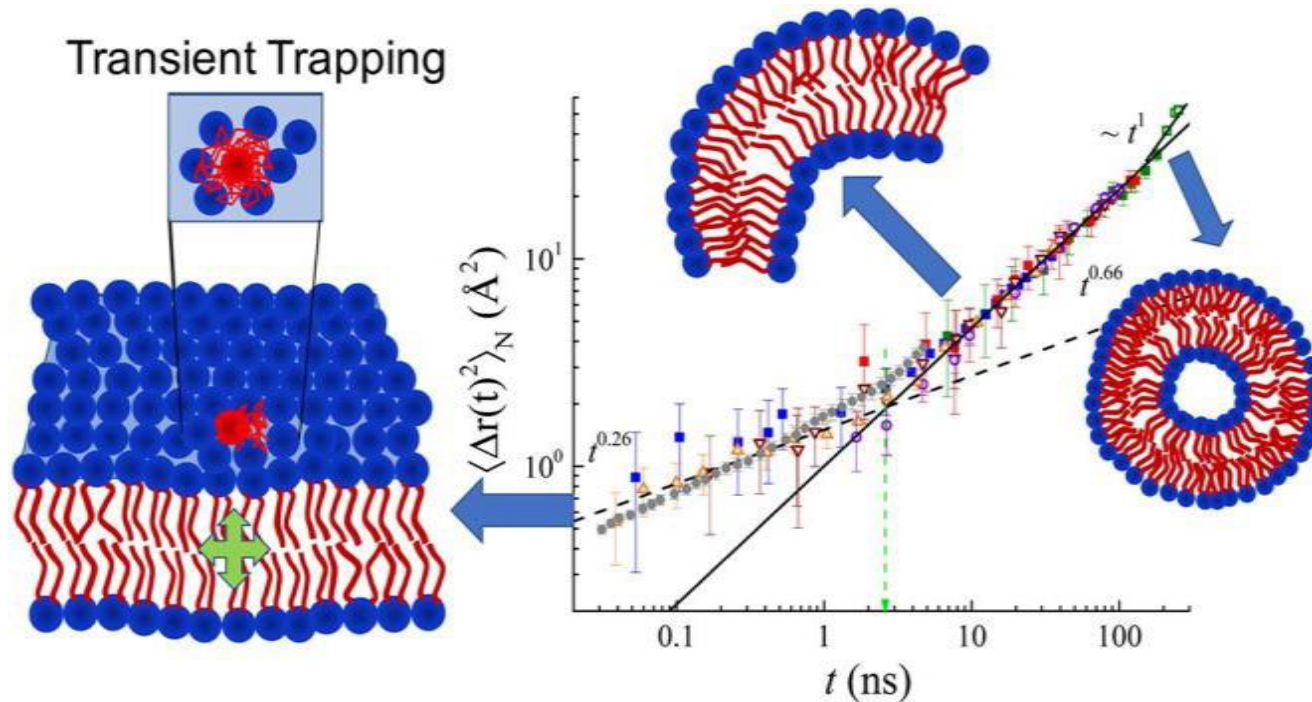

- ❑ Friction at the interface water - liposomes plays a minor role
- ❑ The center of mass diffusion of liposomes and the transient trapping of lipids define the range in which ZG model can be applied

Proposed mechanism of transient trapping and mean square displacement $\langle \Delta r(t)^2 \rangle_N$ as a function of Fourier time

Proteins domains dynamics

L.R. Stingaciu et al., *Sci Rep* 6, 22148 (2016) <https://doi.org/10.1038/srep22148>

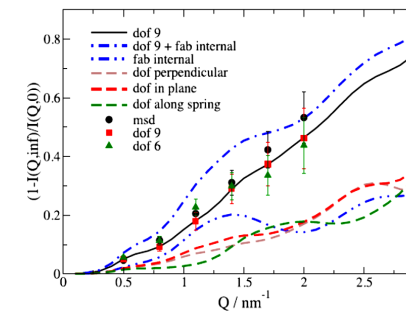
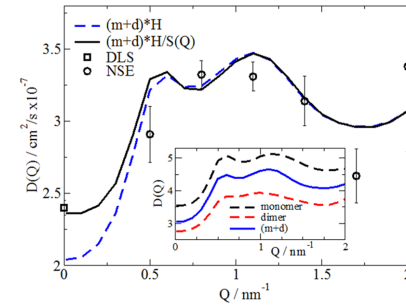
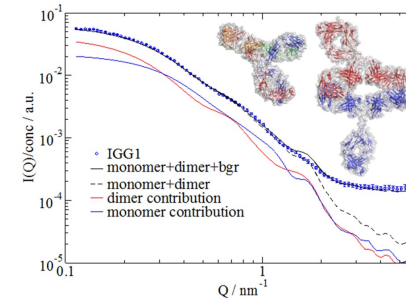
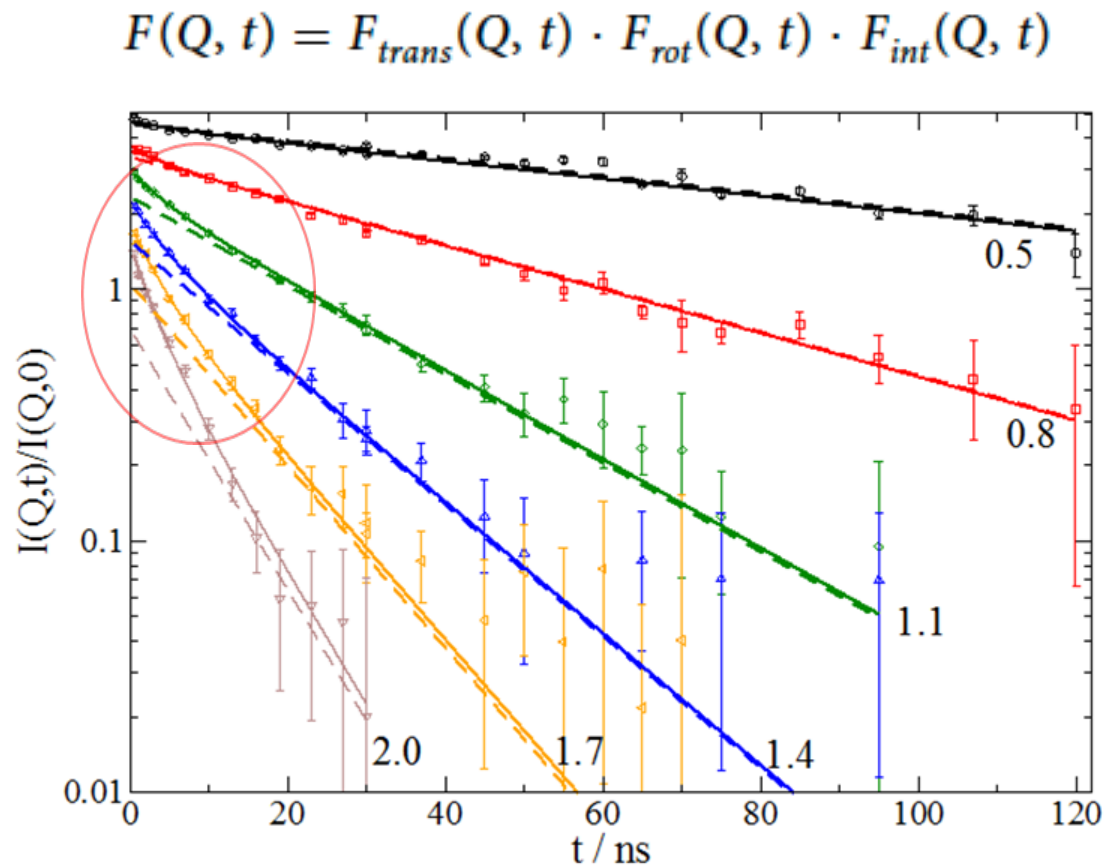

Three protein fragments in harmonic potential connected by flexible linkers

Spin dynamics in frustrated magnets

Yiyao Chen et al., *iScience* 24, <https://doi.org/10.1016/j.isci.2021.102206>

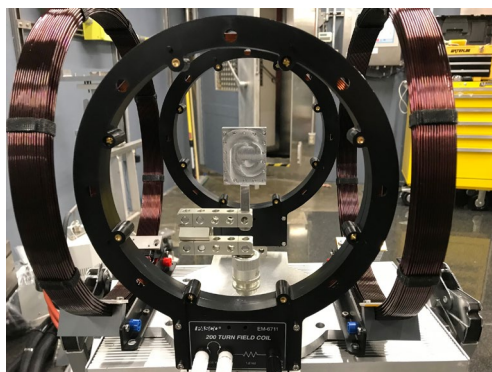

Polarization coils setup at SNS-NSE

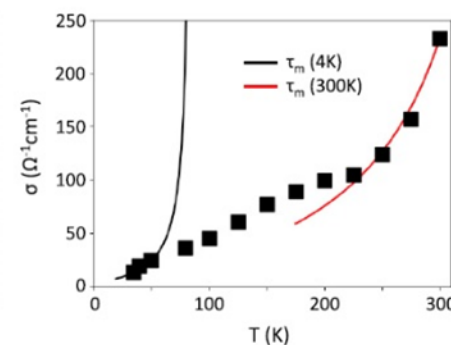
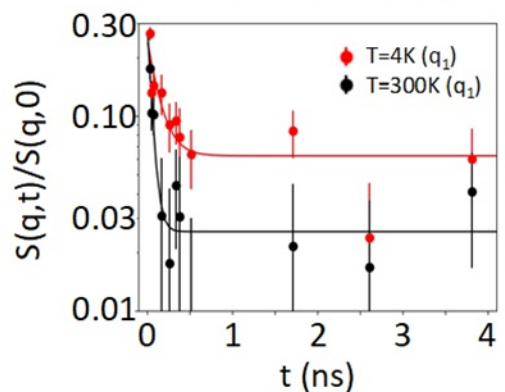
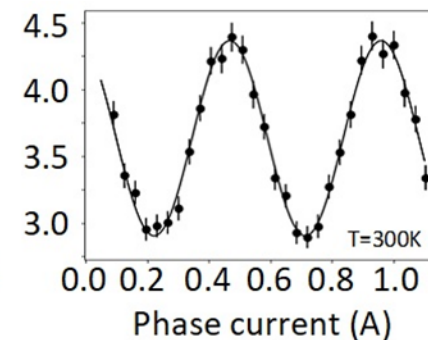
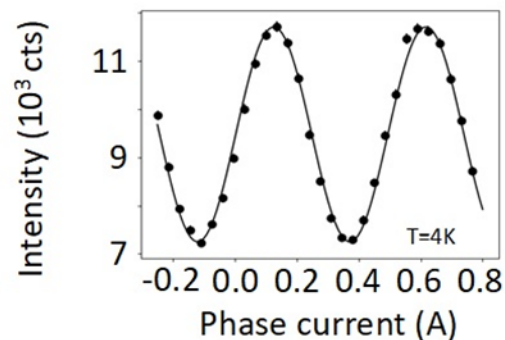
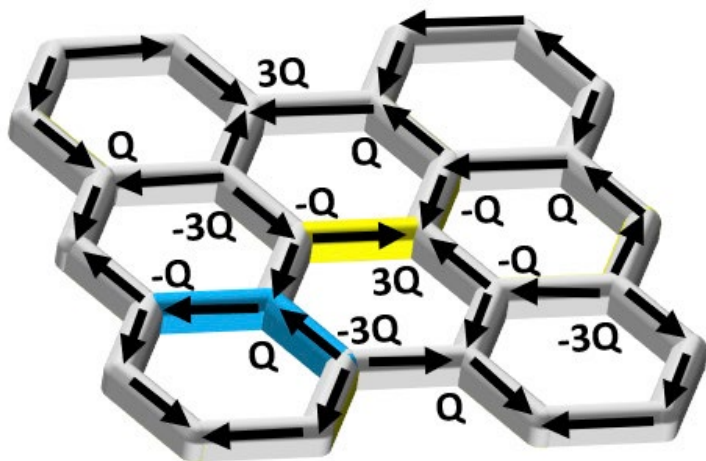

Magnetic charges of $\pm Q$ unit and $\pm 3Q$ accumulate on the vertices of the honeycomb lattice

The charge defect relaxes between nearest neighbors

Neutron Spin Echo Variations

Paramagnetic NSE

Sample is the π -flipper

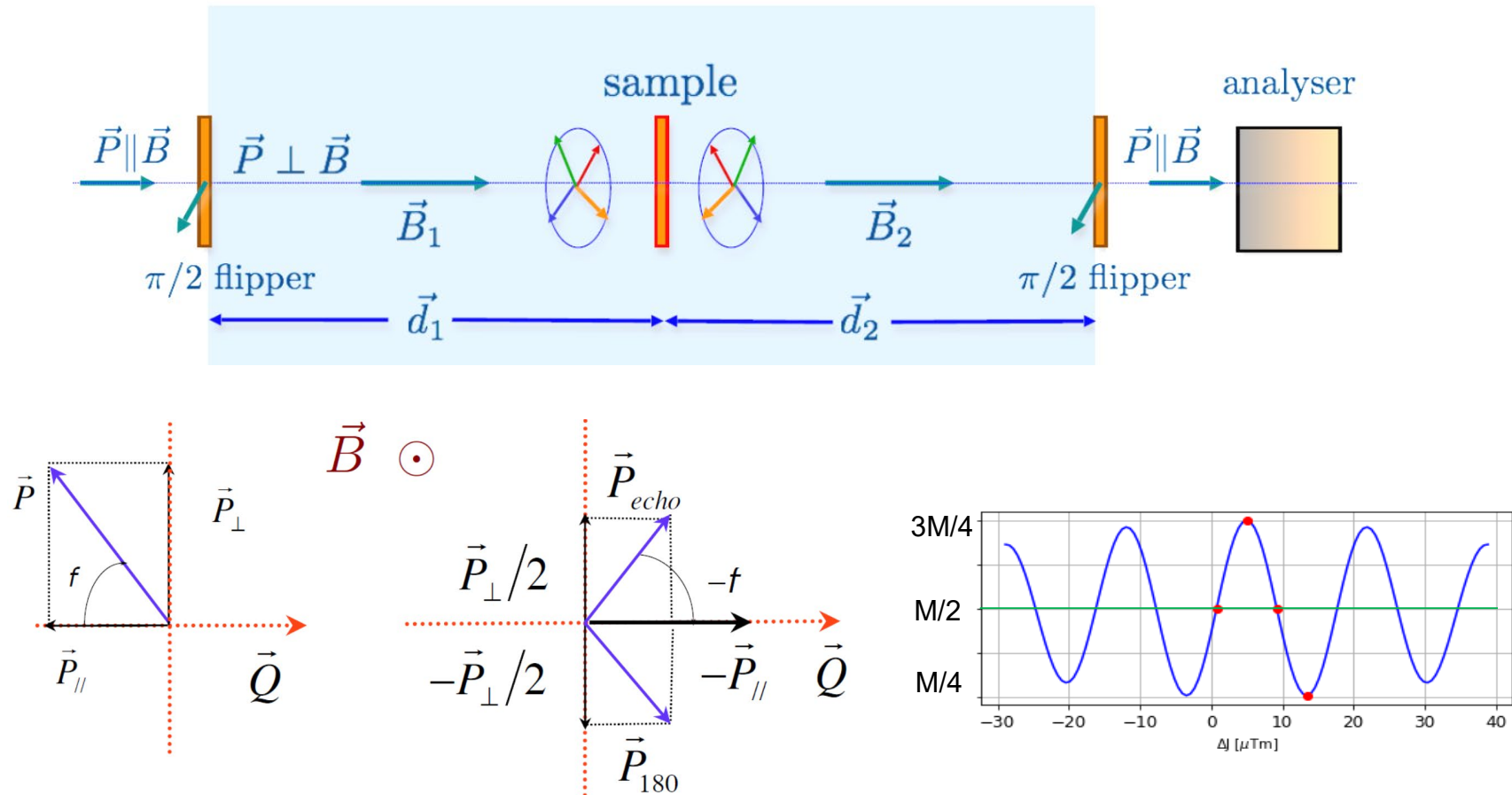

http://sons.uniroma2.it/ericeneutronschool/wp-content/uploads/2016/12/NSE_MAGnetism_Pappas.pdf

Resonance, MIEZE, and SANS - spin echo

NRSE (Neutron Resonance Spin Echo)

T-NRSE or L-NRSE

<https://www-llb.cea.fr/fr-en/pdf/muses-llb.pdf>

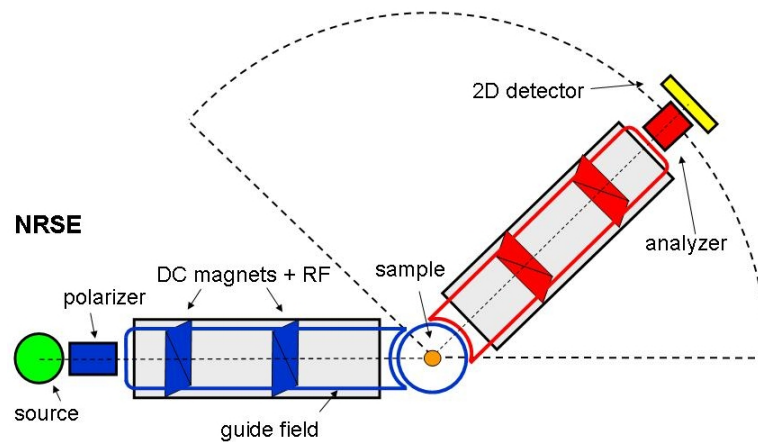

RF field instead of solenoid

- compact design
- shorter Fourier times

SESANS

Spin Echo SANS

http://larmor.weblog.tudelft.nl/files/2013/07/S_Rogers_SANS_SESANS1.pdf

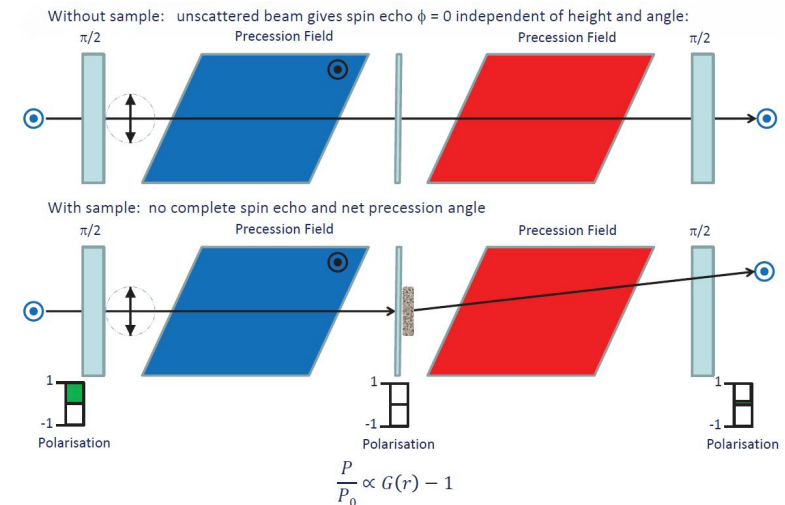

Spin Echo encoded SANS

- tilted magnetic field
- angle encoded in spin precession

Wide angle spin echo

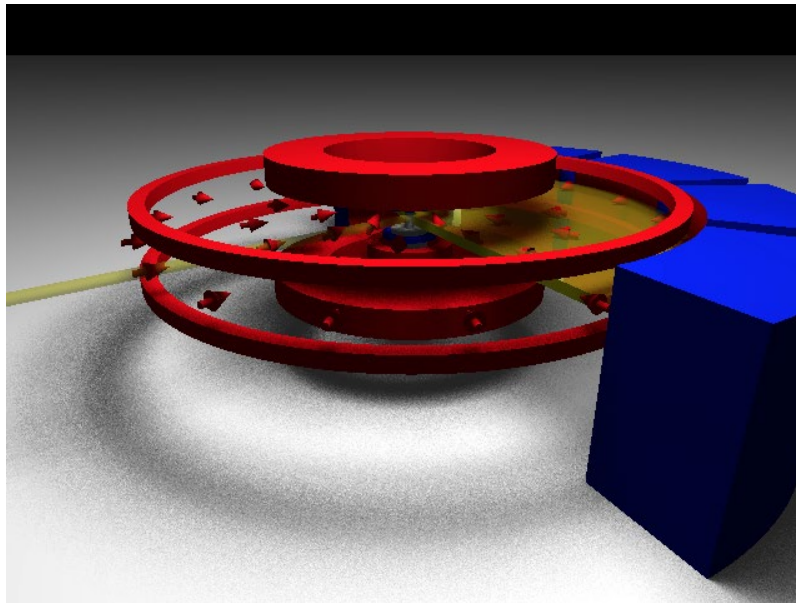

<https://www.ill.eu/users/instruments/instruments-list/wasp/description/instrument-layout>

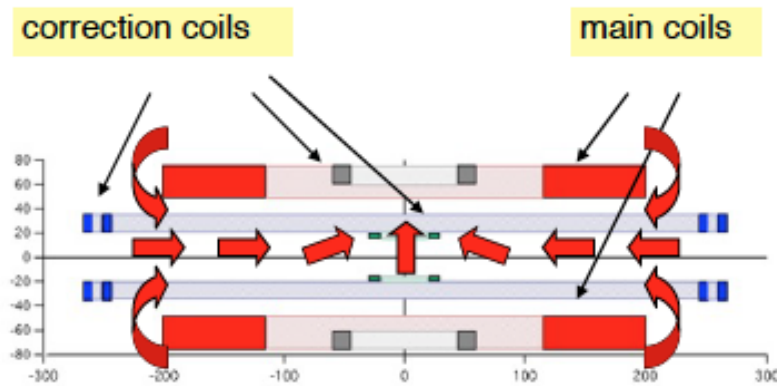
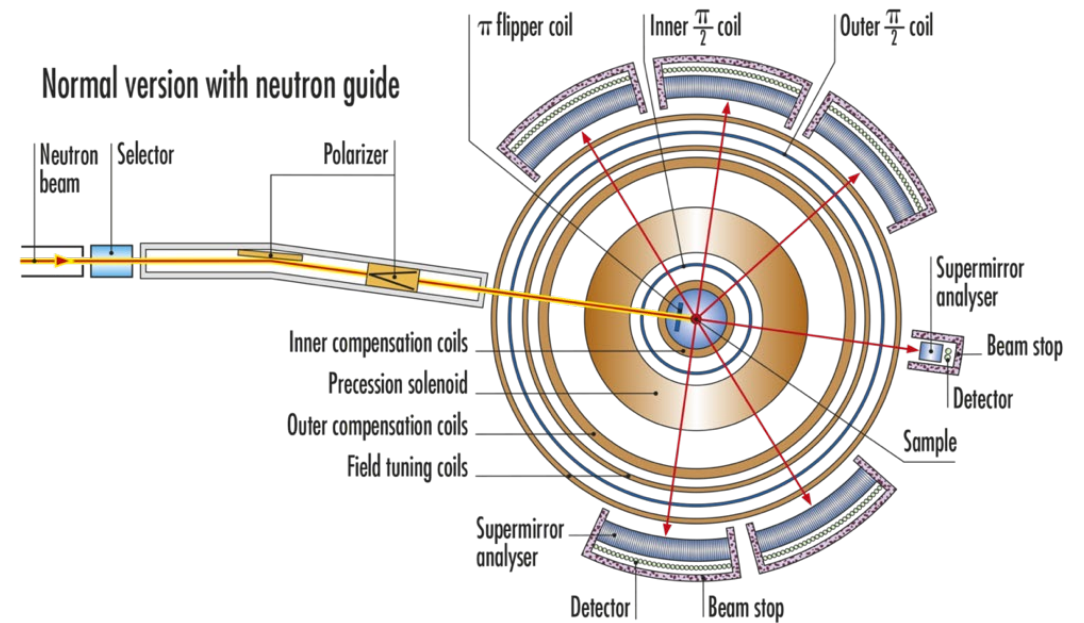

- ❑ Large angular coverage
- ❑ Higher Q (up to 3\AA^{-1})

Summary - NSE in a nutshell

- ❑ NSE measures very small velocity changes using neutron spin precession in magnetic field
- ❑ Broad $\Delta\lambda/\lambda$ and high resolution
- ❑ Intermediate Scattering Function: $I(Q, \tau)$
- ❑ Complementary to SANS/SAXS
- ❑ Counting intensive and large samples

Reference reading

- ❑ R. Pynn, Neutron Scattering, Neutron Spin Echo
http://www.iub.edu/~neutron/notes/20061204_Pynn.pdf
- ❑ F. Mezei (Ed.): Neutron Spin-Echo, Lecture Notes in Physics 128, Springer, 1980.
- ❑ F. Mezei, C. Pappas, T. Gutberlet (Eds.): Neutron Spin-Echo Spectroscopy, Lecture Notes in Physics 601, Springer, 2003.
- ❑ D. Richter, M. Monkenbusch, A. Arbe, J. Colmenero, Neutron Spin Echo in Polymer Systems, Adv. in Polymer Science 174, Springer, 2005
- ❑ M. Monkenbusch, D. Richter, High Resolution Neutron Spectroscopy
<http://doi.org/10.1016/j.crhy.2007.10.001>
- ❑ C.Pappas, G. Ehlers, F. Mezei, Neutron Spin Echo and Magnetism in Neutron Scattering from Magnetic Materials, ed. T. Chatterji, Springer 2006
- ❑ B.Farago, Basics of Neutron Spin-Echo, ILL Neutron Data Booklet,
https://www.ill.eu/fileadmin/users_files/documents/links/documentation/NeutronDataBooklet.pdf

Questions about NSE?

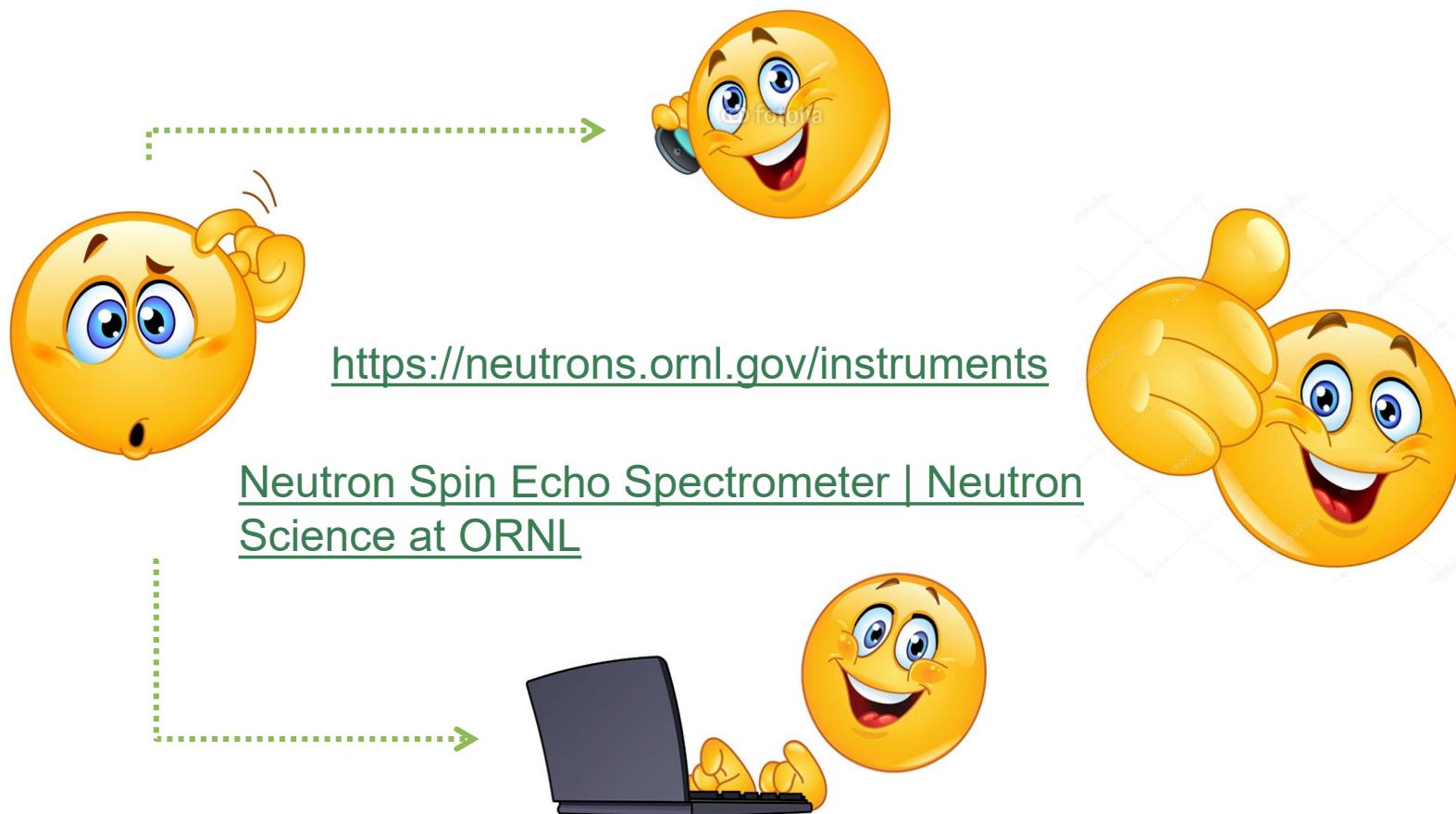

Acknowledgements

- ❑ The research highlights presented here used resources at the Spallation Neutron Source and High Flux Isotope Reactor, as part of the SNS-NSE spectrometer user program, DOE Office of Science User Facility operated by the Oak Ridge National Laboratory
- ❑ SNS-NSE spectrometer Team (P. A. Zolnierczuk & M. Odom)
- ❑ SNS and HFIR facility support groups
- ❑ SNS and HFIR user labs
- ❑ SNS and HFIR User Office
- ❑ US taxpayers

THANK YOU

